

# A Accessories

## Common Accessories

### Contact Blocks and LED Blocks for Ø16 Control Switches

#### Ordering Information



SA	16	CB	W		
Item	Applied switches	Type	LED color <sup>※1</sup>	<b>LED block</b>	<b>R</b> Red
					<b>B</b> Blue
					<b>G</b> Green
					<b>Y</b> Yellow
					<b>W</b> White
		<b>CB<sup>※2</sup></b>	Contact block	B contact (normally closed)	
		<b>CC</b>	C contact (normally open, normally closed)		
		<b>L5</b>	LED block	5VDC	
		<b>L12</b>		12VDC	
		<b>L24</b>		24VDC	
	<b>16</b>	For Ø16 control switches			
	<b>SA</b>	Switch Accessories			

※1. Only for LED blocks.

※2. Only for Ø16 emergency switches.

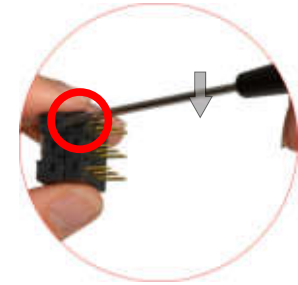
- **Contact block and LED block removal**  
Separate the unit using a flat-head (-) screwdriver.



Item	Appearance	Model	Type	Features
Contact block		SA16-CB	B contact (normally closed)	For Ø16 emergency switches
		SA16-CC	C contact (normally open, normally closed)	—
LED block		SA16-L5□ (5VDC) SA16-L12□ (12VDC) SA16-L24□ (24VDC)	DC voltage type	Diverse, vibrant, high luminance LEDs (red, blue, green, yellow, white)

## ■ Contact Blocks and LED Blocks for Ø22/25, Ø30, □30 Control Switches

### ○ Ordering Information

SA	—	CA	M		
Item	Applied switches	Type	LED color <sup>※1</sup>	LED block	
				LED color <sup>※1</sup>	
	Contact block type	No-mark	Singular type		
		M	Modular type		
	LED color <sup>※1</sup>	No-mark	White		
		R	Red		
		B	Blue		
		G	Green		
		Y	Yellow		
	Contact block	CA	A contact (normally open)		
CB		B contact (normally closed)			
LED block	LD	AC/DC voltage: 12-24VAC 50/60Hz 12-24VDC			
	LA	AC voltage: 110-240VAC 50/60Hz			
For control switches	No-mark	For Ø22/25, Ø30, □30 control switches			
	SA	Switch Accessories			

• **Contact block and LED block removal**  
Separate the unit using a flat-head (-) screwdriver.



※1. Only for LED blocks.

※Multi-unit connection is only available for modular type (SA-□M).

Item	Appearance	Model	Type	Features
Modular type contact block		SA-CAM	A contact (normally open)	Ring or spade terminals / Multi-connection (up to 3 units)
		SA-CBM	B contact (normally closed)	
Singular type contact block		SA-CA	A contact (normally open)	Spade terminals only / Loose screw prevention
		SA-CB	B contact (normally closed)	
Modular type LED block		SA-LD□M	AC/DC voltage type 12-24VAC 50/60Hz 12-24VDC	Diverse, vibrant, high luminance LEDs (Red, Blue, Green, Yellow, White)
		SA-LA□M	AC voltage type 110-220VAC 50/60Hz	
Singular type LED block		SA-LD□	AC/DC voltage type 12-24VAC 50/60Hz 12-24VDC	Diverse, vibrant, high luminance LEDs (Red, Blue, Green, Yellow, White)
		SA-LA□	AC voltage type 110-220VAC 50/60Hz	

#### Control Switches

Ø16

Ø22/25

Ø30

□30

#### Push Button Switches

Round

Square

Rectangular

#### Selector Switches

Round

Square

Rectangular

#### Key Selector Switches

Round

Square

Rectangular

#### Double Push Button Switches

#### Mushroom-head Push Button Switches

#### Emergency Switches

#### Pilot Lights

#### Accessories

#### Buzzers

# A Accessories

## Switch Enclosures for Ø22/25 Control Switches

### Ordering Information

SA	—	SB	3
Item	Applied switches	Appearance	Holes
			1
			2
			3
			4
5			
Item	Applied switches	SB	Square type
		TB	Triangle type
Item	Applied switches	No-mark	For Ø22/25 control switches
		SA	Switch accessories



※You can order the other size and the number of holes.

• Hole size: Ø22.5/25.5mm

(unit: mm)

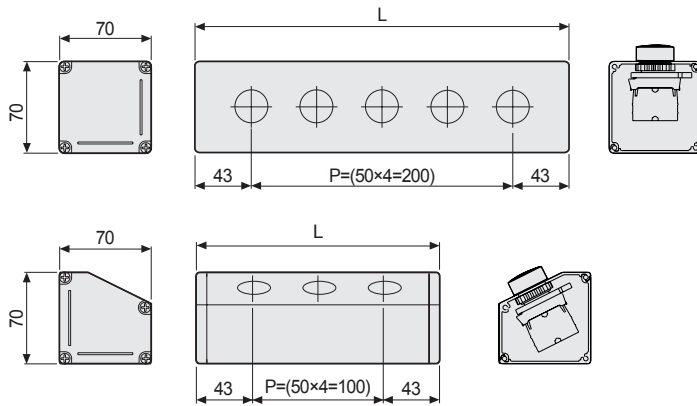

Holes	L
1	86mm
2	136mm
3	186mm
4	236mm
5	286mm













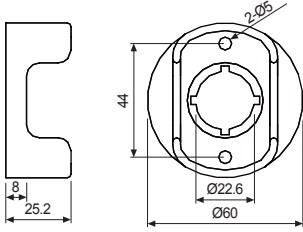

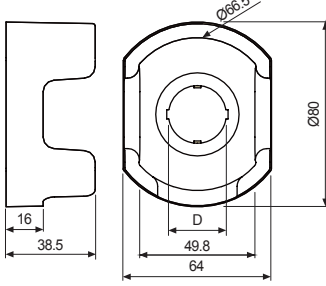
## Locking Handle for Switches

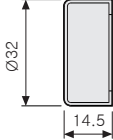
Applied switches	Appearance	Model	Note
Ø16		SA16-LH	For locking switch nuts behind the panels
Ø22/25, Ø30 <sup>※1</sup> , □30		SA-LH	

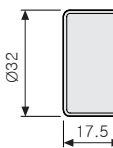
※1. Except Ø30 round pressure switches (extended).

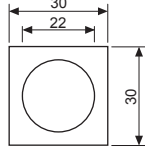
## Accessories By Item

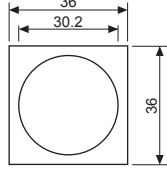
(unit: mm)

Item	Appearance	Model	Dimensions	Note						
Emergency switch nameplates		SA-NS	Size: D60×d25	Standard and illuminated nameplates are available for emergency switches. ※Illuminated nameplates are optional. ※D60 emergency switches (S2ER-E5R□) are not compatible with SA-NS nameplates						
		SA-NL	Size: D80×d25							
Protective shrouds for emergency switches		SA-EG1		Protective shrouds to prevent accidental/incorrect operation <table border="1" style="margin-left: 20px;"><thead><tr><th colspan="2">D</th></tr></thead><tbody><tr><td>SA-EG2</td><td>Ø22.5</td></tr><tr><td>SA-EG3</td><td>Ø25.5</td></tr></tbody></table> ※Not available for D60 emergency switches (S2ER-E5R□).	D		SA-EG2	Ø22.5	SA-EG3	Ø25.5
	D									
SA-EG2	Ø22.5									
SA-EG3	Ø25.5									
	SA-EG2/ SA-EG3									
Waterproof cap for Ø22/25 round push button switches		SA-WP (non-illuminated/ extended)		IP65 protection structure with waterproof cap						
	 (extended)	SA-WL (illuminated/ extended)								
Ø20/25 Switch washer		SA-SW2		The washer helps to improve switch tightening force.						
Ø30 Switch washer		SA-SW3								
Lens remover for Ø16 push button control switches or pilot lights		SA16-RM		Lens remover for push button control switches or pilot lights						

Control Switches

Ø16

Ø22/25

Ø30

□30

Push Button Switches

Round

Square

Rectangular

Selector Switches

Round

Square

Rectangular

Key Selector Switches

Round

Square

Rectangular

Double Push Button Switches

Mushroom-head Push Button Switches

Emergency Switches

Pilot Lights

Accessories

B buzzers